

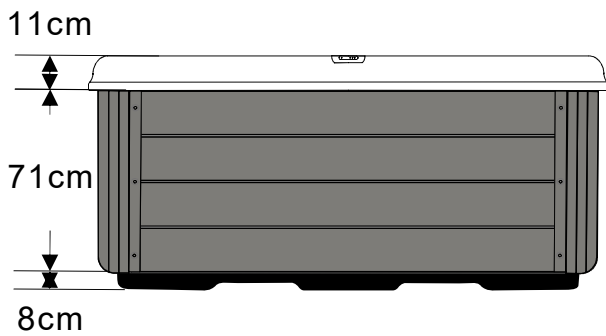

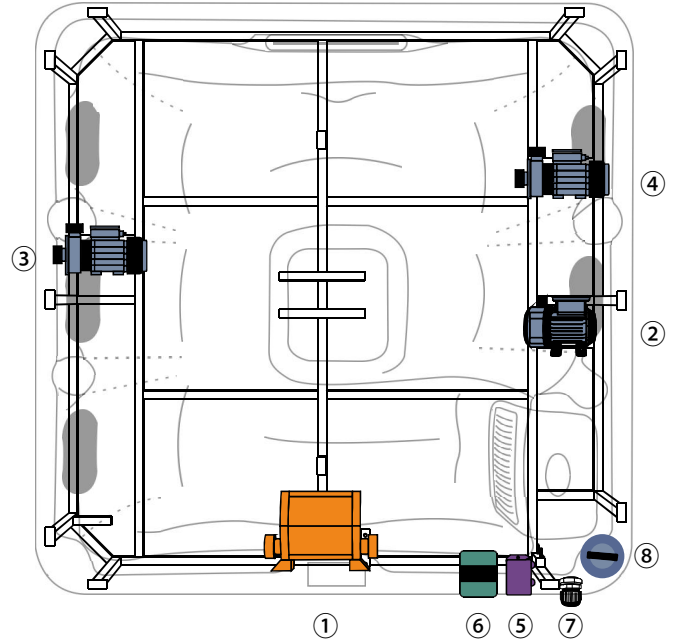

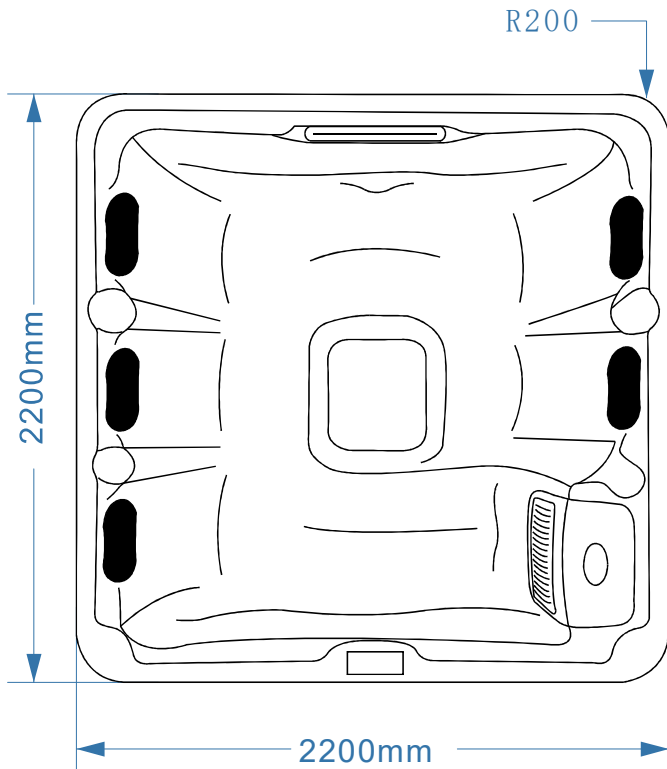



MG-03:2200x2200x900mm

Gecko YE-5(V3)/Config 2 /230v/1phase/ 32 A



No.	Items	Part n°
①		Controller
②		SPA circulation pump(WTC50)
③		Massage pump 1:LP300
④		Massage pump 2:LP200
⑤		LED Synchronizer
⑥		Ozone
⑦		PG head
⑧		Drainage