

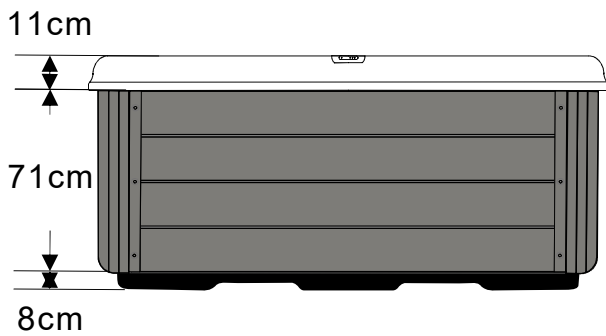

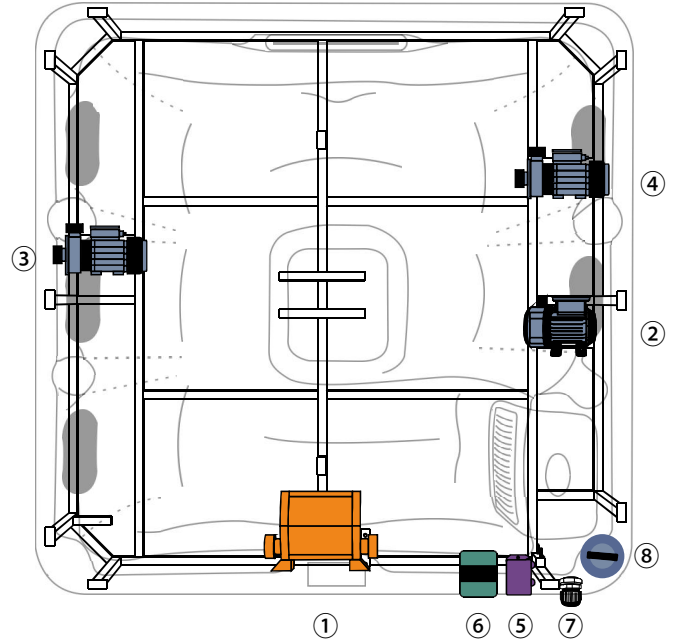

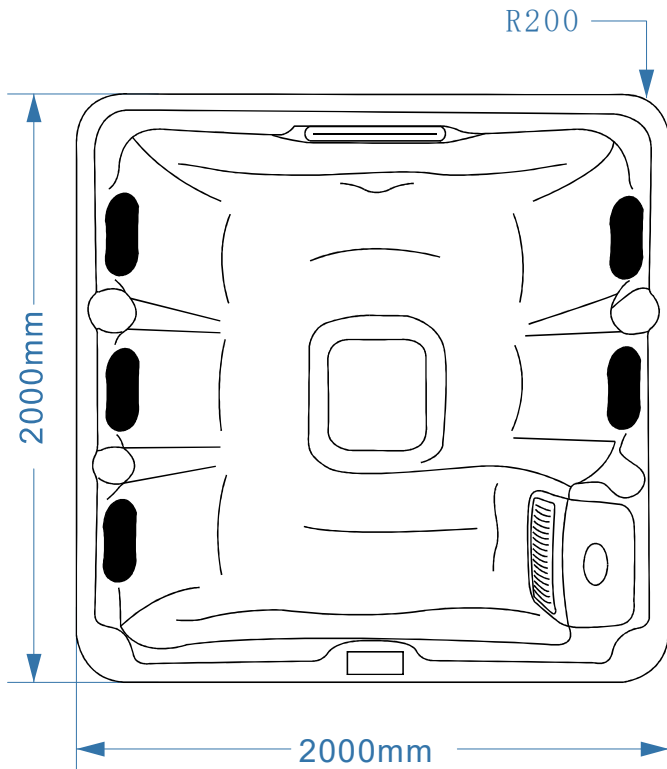



# MG-01:2000x2000x900mm

Gecko YE-5(V3)/Config 2 /230v/1phase/ 32 A







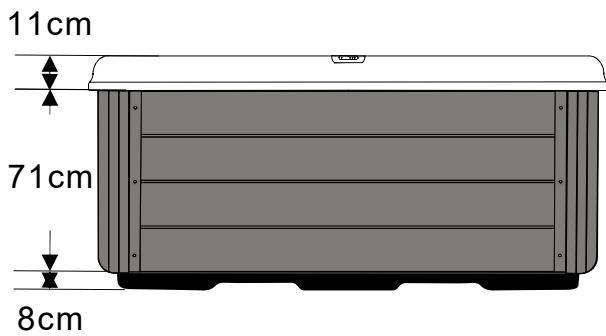
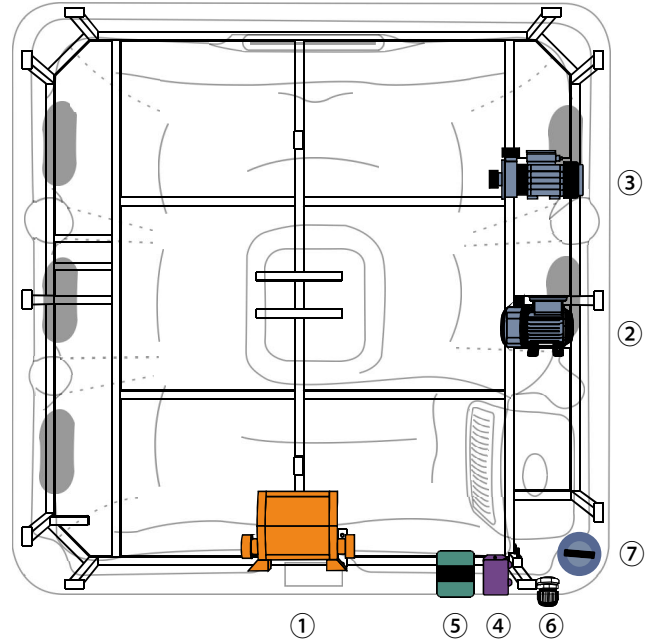
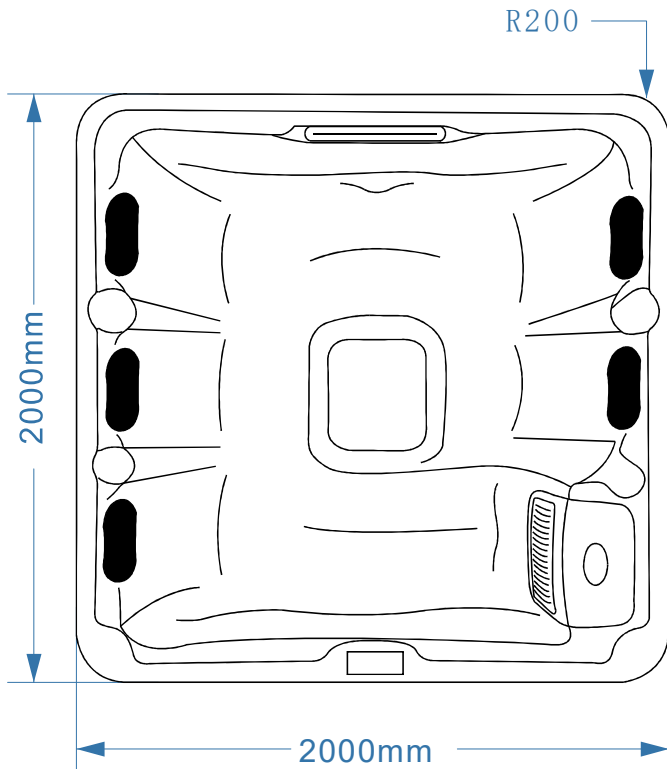

No.	Items	Part n°
①		Controller
②		SPA circulation pump(WTC50)
③		Massage pump 1:LP300
④		Massage pump 2:LP200
⑤		LED Synchronizer
⑥		Ozone
⑦		PG head
⑧		Drainage

# MG-01:2000x2000x900mm

Gecko YJ-2(V3) /Config 23 /230v/1phase/ 13 A



No. Items	Part n°
①	 Controller
②	 SPA circulation pump(WTC50)
③	 Massage pump 1:LP300
④	 LED Synchronizer
⑤	 Ozone
⑥	 PG head
⑦	 Drainage